



EXEN

ALL EYES ARE ON

Catalogue

Founded in 2023 under the Kaçmaz Group in Arnavutköy, İstanbul, EXEN Elektrik draws strength from the deep-rooted experience and expertise of both its founding partners and team in the switch socket industry. Combining this extensive experience with its determined and visionary goals, along with a strong team, Kaçmaz Group confidently carries its past expertise into the future as EXEN.

Having successfully completed its production infrastructure in just one year, EXEN began representing our country internationally as of January 2024, and is proud to now be meeting with you, our valued customers, in Turkey.



With its ongoing R&D and investment activities, EXEN is determined to maintain the momentum gained since its inception in a steady manner. Offering high-quality, durable, and affordable products, EXEN is set to add value to your life and spaces.

EXEN

ALL EYES ARE **ON**



INDEX

ABOUT US		6
<hr/>		
KAREL	Colors	17
	Product Range	18
	Whole Product	22
	Mechanism	25
<hr/>		
	Colors	29
	Product Range	30
	Whole Product	34
	Mechanism	37
<hr/>		
	Colors	41
	Product Range	42
	Mechanism	46
<hr/>		
TECHNICAL INFORMATION	Technical Drawings	50
	Some Basics	54
	Diagrams	56

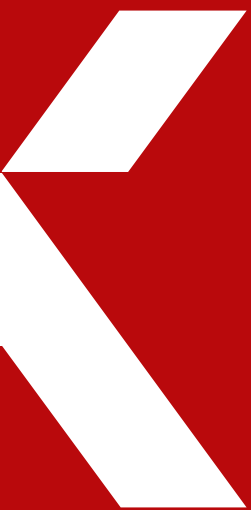

EXPERIENCED

Innovative, Reliable, and Flawless. EXEN is Now with You.

Founded in 1996 in Karaköy, İstanbul, under the name İrem Elektrik, KAÇMAZ Group consolidated its entire product range under the HOROZ brand in 2007 at the İstanbul Thrace Free Zone. HOROZ Elektrik produces over 2,000 products in the Republic of China in compliance with EU standards and exports these products to more than 70 countries through its group companies located in 12 countries.

In 2009, TEB Elektrik was established in Arnavutköy, İstanbul, with the aim of producing various electrical and lighting products in Turkey and contributing to the national economy. Local production models were also added to the Horoz product range. In 2011, these companies were brought together under the KAÇMAZ Group umbrella, and since 2015, significant investments have been made in the construction sector. KAÇMAZ Group has built a substantial number of residential units in this sector and has invested in numerous projects.

In 2023, KAÇMAZ Group began investing in the switch and socket industry under the EXEN Elektrik brand, and by 2024, it completed its establishment process and started representing our country both domestically and internationally.



70+
Export
to the country

1000+
Personnel
Employment

20
Group
Company

2000+
Product
Range

KaçmazGrup

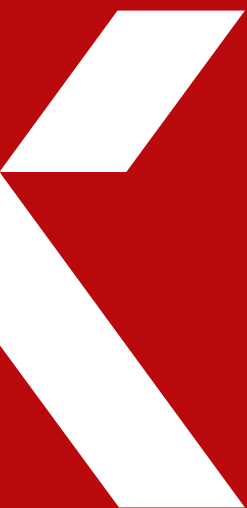

HIGH-QUALITY

Discover EXEN quality.

EXEN continues its journey with the aim of being a reliable and innovative brand in the industry by combining domestic and national capital with a team that has over 30 years of sectoral experience. Having started production in its modern facilities located in Arnavutköy, İstanbul, which cover an area of 25,000 m² indoors and 10,000 m² outdoors, EXEN carries out extensive R&D activities for the future, ranging from switchgear systems to surface-mounted products, IP-protected devices, and modular systems. With its dynamic and confident team, EXEN is determined to shape the industry and build the future.

Our approach, which aims for perfection in every detail, strengthens the robust and reliable structure of our products while reinforcing this quality through superior material selection and craftsmanship. Our strong design lines combine aesthetics and durability, consistently elevating EXEN ahead of the competition.

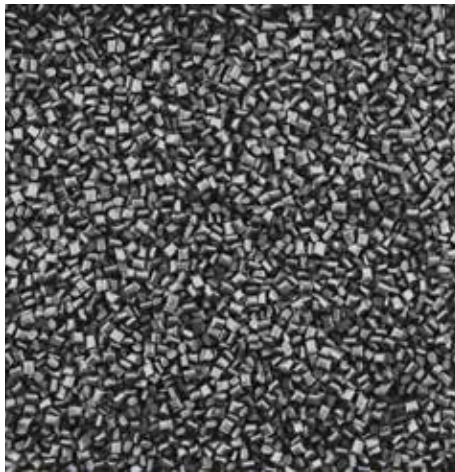

Power
that emerges from the depths

Discover
the nature of quality

EXEN
ALL EYES ARE ON



POWERFUL

EXEN, Always ready

EXEN provides quick and effective solutions to its customers' needs at all times, thanks to its strong inventory structure. Every product that reaches our customers from our factory is part of a dynamic process driven by the principles of reliability and efficiency.

With our stock strength, we are always ready to meet demands.



As a strong partner of Horoz Elektrik, Exen serves every corner of Turkey and hundreds of locations worldwide with its industry experience and innovative approach. With our strong inventory structure, we respond quickly to customer demands and provide reliable solutions.



INNOVATIVE

Discover the details

With its experienced team, EXEN aims to provide user-oriented, reliable, and innovative solutions. It produces products that comply with TSE and European standards, testing them in its in-house laboratory under ISO standards. With a strong, innovative, and dynamic production process, EXEN is capable of providing instant and rapid solutions to all its customers' needs. Thanks to its approach focused on creating solution-oriented designs, it offers a combination of quality and usability.

(IEC 60669-1, IEC 60884-1, ISO 9001:2015, ISO 10002:2018)



Quality and flawless mechanism

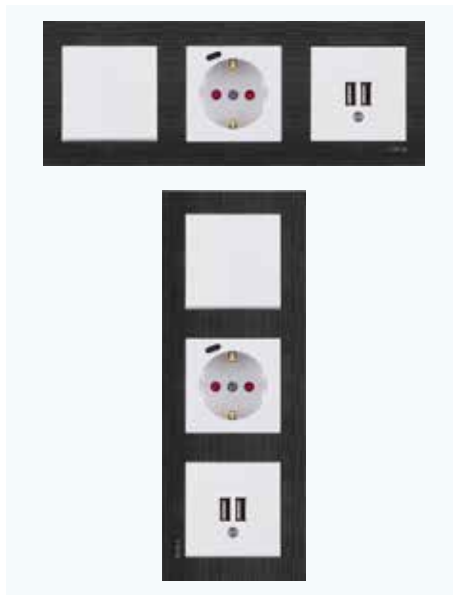

A single solution for different scenarios with its symmetrical design



KAREL

ODAK

COMFORT

One mechanism, unlimited combinations

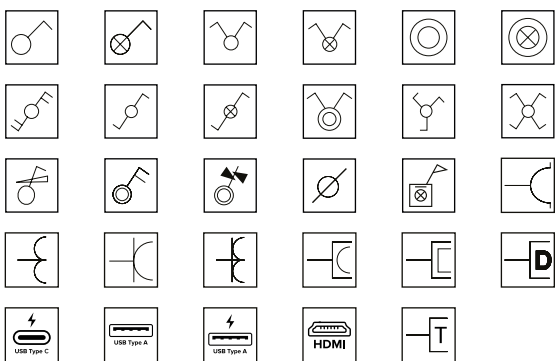

Continuously expanding mechanism systems that will provide solutions for various scenarios.

One Mechanism Three Series

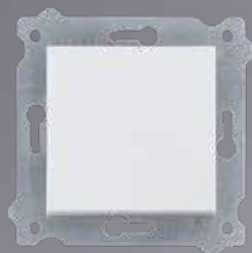

+

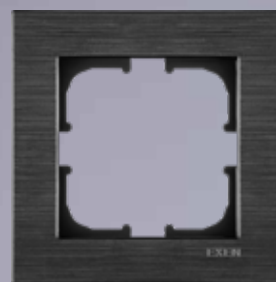
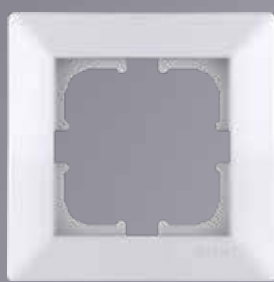
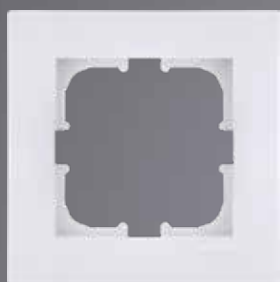

=



KAREL

DAK

COMFORT



EXEN | ALL EYES ARE **ON**



Creating your dream EXEN is very easy; you can freely combine EXEN mechanisms with your desired series and colors. Enjoy the freedom with series that feature a symmetrical design.

ALL
in
ONE



EXEN | ALL EYES ARE **ON**



KAREL

Series





White



Silver



Smoked Gray



Titanium



Anthracite



Metallic Black



Mocha

SWITCH



One Way Switch
200-010102-200
10AX 250V ~ I EN 60669-1



One Way Double Switch
200-010102-202
10AX 250V ~ I EN 60669-1



Door Push Switch
200-010102-204
10A 250V ~ I EN 60669-1



Light Switch
200-010102-205
10A 250V ~ I EN 60669-1



Doorbell Switch
200-010102-207
10A 250V ~ I EN 60669-1



Double Light Switch
200-010102-208
10A 250V ~ I EN 60669-1



Two Way Switch (Veavien)
200-010102-209
10AX 250V ~ I EN 60669-1



Two Way Double Switch (Commutator Veavien)
200-010102-211
10AX 250V ~ I EN 60669-1

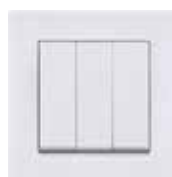

Triple Switch
200-010102-213
10AX 250V ~ I EN 60669-1



Intermediary Veavien Switch (Permutator)
200-010102-214
10AX 250V ~ I EN 60669-1



Shutter Control Switch (Jalousie)
200-010102-216
10A 250V ~ I EN 60669-1



Non-Spring-Loaded Shutter Control Switch (Jalousie)
200-010102-217
10A 250V ~ I EN 60669-1



Double One-way Push Button
200-010102-220
10A 250V ~ I EN 60669-1

ILLUMINATED SWITCH



Illuminated One Way Switch
200-010102-201
10AX 250V ~ I EN 60669-1



Illuminated One Way Double Switch
200-010102-203
10AX 250V ~ I EN 60669-1



Illuminated Light Switch
200-010102-206
10A 250V ~ I EN 60669-1



Illuminated Two Way Switch (Illuminated Veavien)
200-010102-210
10AX 250V ~ I EN 60669-1



Illuminated One Way Switch (16A)
200-010102-215
16AX 250V ~ I EN 60669-1

DIMMER



Dimmer 800W
200-010102-225
800W 250V ~ EN 60669-2-2



Music Broadcasting Switch
200-010102-226



Two Way Dimmer 500W
200-010102-227
500W 250V ~ EN 60669-2-2





SOCKET





Socket 2P

200-010103-235
16A 250V ~ I EC 60884-1

Earthed Socket (Schuko) 2P+E

200-010103-237
16A 250V ~ I EC 60884-1

Child Protection Earthed Socket 2P+E

200-010103-238
16A 250V ~ I EC 60884-1





Earthed Socket with Outlet Cover (Schuko) 2P+E

200-010103-239
16A 250V ~ I EC 60884-1





Child Protection Earthed Socket with Outlet Cover 2P+E



200-010103-240
16A 250V ~ I EC 60884-1





UPS Socket (French Type)

200-010103-241
16A 250V ~ I EC 60884-1

Child Protection UPS Socket (French Type)





200-010103-242
16A 250V ~ I EC 60884-1





Earthed Socket with Type-C (20W Fast Charger)

200-010103-274
16A 250V ~ I EC 60884-1
Output: 5V-3A/9V-2.22A/12V-1.62A/20W

Two-Gang Socket

200-010103-244
10A 250V ~ I EC 60884-1





Two-Gang Earthed Socket

200-010103-245
16A 250V ~ I EC 60884-1





USB Charger Socket

200-010103-267
Output: 2.1A-5V-10W



2X USB Charger Socket

200-010103-268
Output: 2.1A-5V-10W



TV - SAT



TV Socket with PCB (Through of Line)

200-010103-257



TV Socket with PCB (End of Line)

200-010103-258



TV Socket Filtered (Through of Line)

200-010103-259



TV Socket Filtered (End of Line)

200-010103-260





SAT Socket (F Connector)

200-010103-261



SAT Socket Filtered (F Connector)

200-010103-262



TV-SAT Socket (Through of Line)

200-010103-263



TV-SAT Socket (End Of Line)

200-010103-264



Cable Outlet

200-010103-265

ELECTRONIC



Energy Saver Optic with Illuminated + Delayed

200-010102-221



Energy Saver Micro Switch with Illuminated + Delayed

200-010102-222



Energy Saver Micro Switch with Illuminated + No Delayed

200-010102-223



RFID Energy Saver with illuminated + Delayed

200-010102-224



Energy Saver without PCB

200-010102-228

COMMUNICATION



Numeric Telephone Socket (623K)

200-010103-250



Numeric Telephone Socket (CAT3 without Cable)

200-010103-251



Two-Gang Numeric Telephone Socket (2xRJ45 CAT3)

200-010103-252



Data Socket CAT6

200-010103-253



Double Data Socket CAT6

200-010103-254



Data Socket without Jack

200-010103-255



Data CAT6 + Numeric Telephone Socket CAT3

200-010103-256



USB Socket with Jack (No Charge)

200-010103-266



HDMI Socket with Jack

200-010103-269



HDMI + DATA Socket with Jack

200-010103-270



DATA + USB Socket with Jack (No Charge)

200-010103-271



HDMI + USB Socket with Jack (No Charge)

200-010103-272



Fiber Optic

200-010103-273



FRAME

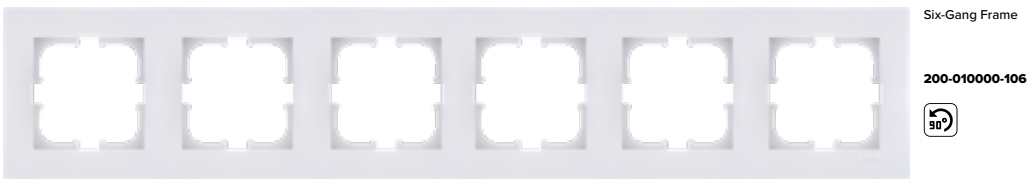
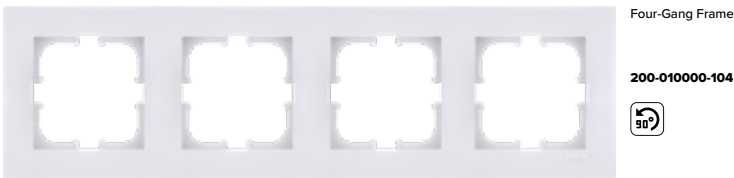
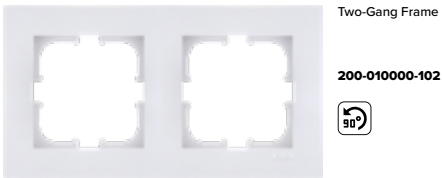
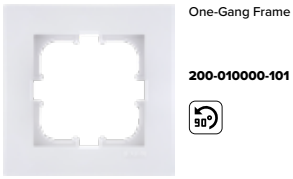

KAREL Sales Options

1. Whole Product



2. Mechanism + Frame



ALL
in
ONE

Please remember that all series use a common mechanism system

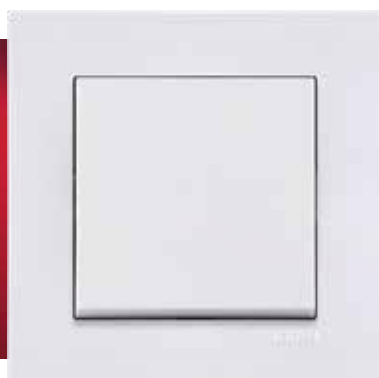

WHOLE PRODUCT

COLOR OPTIONS



01
WHITE



10
SILVER



11
SMOKED GRAY



12
TITANIUM



13
ANTHRACITE



14
METALLIC BLACK



15
MOCHA

CODE STRUCTURE

200-XXYY0A-ZZZ
WHOLE PRODUCT

XX : Frame Color

YY : Cover Color

ZZZ : Product Type



CODE	DESCRIPTION	BOX	CARTON
SWITCH			
200-XXYY02-200	One Way Switch	12	120
200-XXYY02-202	One Way Double Switch (Commutator)	12	120
200-XXYY02-204	Door Push Switch	12	120
200-XXYY02-205	Light Switch	12	120
200-XXYY02-207	Doorbell Switch	12	120
200-XXYY02-208	Double Light Switch (Commutator Light)	12	120
200-XXYY02-209	Two Way Switch (Veavien)	12	120
200-XXYY02-211	Two Way Double Pole Switch (Commutator Veavien)	12	60
200-XXYY02-213	Triple Switch	12	120
200-XXYY02-214	Intermediary Veavien (Permutator) Switch	12	60
200-XXYY02-216	Shutter (Jalousie) Control Switch	12	60
200-XXYY02-217	Non-Spring-Loaded Shutter (Jalousie) Control Switch	12	60
200-XXYY02-220	Double One-way Push Button	12	60



WHOLE PRODUCT



CODE	DESCRIPTION	BOX	CARTON
ILLUMINATED SWITCH			
200-XXYY02-201	Illuminated One Way Switch	12	120
200-XXYY02-203	Illuminated One Way Double Switch (Illuminated Commutator)	12	120
200-XXYY02-206	Illuminated Light Switch	12	120
200-XXYY02-210	Illuminated Two Way Switch (Illuminated Veavien)	12	60
200-XXYY02-215	Illuminated One Way Switch (16A)	12	60
DIMMER			
200-XXYY02-225	Dimmer 800W	10	50
200-XXYY02-226	Music Broadcasting Switch	10	50
200-XXYY02-227	Two Way Dimmer (Veavien Dimmer) 500W	10	50
SOCKET			
200-XXYY03-235	Socket 2P	12	120
200-XXYY03-237	Earthed Socket (Schuko) 2P+E	12	120
200-XXYY03-238	Child Protection Earthed Socket 2P+E	12	120
200-XXYY03-239	Earthed Socket with Outlet Cover (Schuko) 2P+E	10	100
200-XXYY03-240	Child Protection Earthed Socket with Outlet Cover 2P+E	10	100
200-XXYY03-241	UPS Socket (French Type)	12	120
200-XXYY03-242	Child Protection UPS Socket (French Type)	12	120
200-XXYY03-244	Two-Gang Socket	8	80
200-XXYY03-245	Two-Gang Earthed Socket	6	60
200-XXYY03-267	USB Charger Socket	12	60
200-XXYY03-268	2X USB Charger Socket	12	60
200-XXYY03-274	Earthed Socket (Schuko) 2P+E with Type-C	8	40
TV-SAT			
200-XXYY03-257	TV Socket Through of Line with PCB	12	120
200-XXYY03-258	TV Socket End of Line with PCB	12	120
200-XXYY03-259	TV Socket Through of Line Filtered	12	120
200-XXYY03-260	TV Socket End of Line Filtered	12	120
200-XXYY03-261	SAT Socket (F Connector)	12	120
200-XXYY03-262	SAT Socket (F Connector) Filtered	12	50
200-XXYY03-263	TV-SAT Socket (Through of Line)	12	60
200-XXYY03-264	TV-SAT Socket (End Of Line)	12	60
200-XXYY03-265	Cable Outlet	12	60

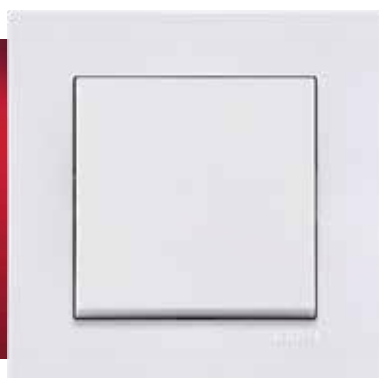

WHOLE PRODUCT

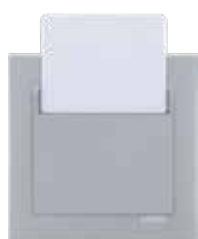

CODE	DESCRIPTION	BOX	CARTON
ELECTRONIC			
200-XXYY02-221	Energy Saver Optic with Illuminated + Delayed	12	60
200-XXYY02-222	Energy Saver Micro Switch with Illuminated + Delayed	12	60
200-XXYY02-223	Energy Saver Micro Switch with Illuminated + No Delayed	12	60
200-XXYY02-224	RFID Energy Saver with illuminated + Delayed	12	60
200-XXYY02-228	Energy Saver without PCB	12	60
COMMUNICATION			
200-XXYY03-250	Numeric Telephone Socket (623K)	12	120
200-XXYY03-251	Numeric Telephone Socket (CAT3 without Cable)	12	60
200-XXYY03-252	Two-Gang Numeric Telephone Socket (2xRJ45 CAT3)	12	60
200-XXYY03-253	Data Socket CAT 6	12	60
200-XXYY03-254	Double Data Socket CAT 6	12	60
200-XXYY03-255	Data Socket without Jack	12	60
200-XXYY03-256	Data CAT6 + Numeric Telephone Socket CAT3	12	60
200-XXYY03-266	USB Socket (No Charge) with JACK	12	60
200-XXYY03-269	HDMI Socket with JACK	12	60
200-XXYY03-270	HDMI + DATA Socket with JACK	12	60
200-XXYY03-271	DATA + USB Socket (No Charge) with JACK	12	60
200-XXYY03-272	HDMI + USB Socket (No Charge) with JACK	12	60
200-XXYY03-273	Fiber Optic	12	60
FRAME			
200-XX0000-101	One-Gang Frame	24	240
200-XX0000-102	Two-Gang Frame	24	120
200-XX0000-103	Three-Gang Frame	24	120
200-XX0000-104	Four-Gang Frame	12	60
200-XX0000-105	Five-Gang Frame	12	60
200-XX0000-106	Six-Gang Frame	12	60

The frames are suitable for both vertical and horizontal use.



MECHANISMS



COLOR OPTIONS



01
WHITE

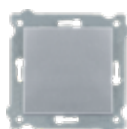

10
SILVER

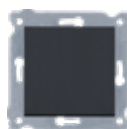

11
SMOKED GRAY

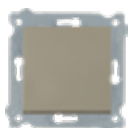

12
TITANIUM

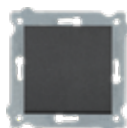

13
ANTHRACITE



14
METALLIC BLACK

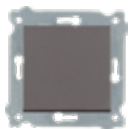

15
MOCHA

CODE STRUCTURE

290-00YY0A-ZZZ
MECHANISMS

YY : Cover Color

ZZZ : Product Type

CODE	DESCRIPTION	BOX	CARTON
SWITCH			
290-00YY02-200	One Way Switch	12	120
290-00YY02-202	One Way Double Switch (Commutator)	12	120
290-00YY02-204	Door Push Switch	12	120
290-00YY02-205	Light Switch	12	120
290-00YY02-207	Doorbell Switch	12	120
290-00YY02-208	Double Light Switch (Commutator Light)	12	120
290-00YY02-209	Two Way Switch (Veavien)	12	120
290-00YY02-211	Two Way Double Pole Switch (Commutator Veavien)	12	60
290-00YY02-213	Triple Switch	12	120
290-00YY02-214	Intermediary Veavien (Permutator) Switch	12	60
290-00YY02-216	Shutter (Jalousie) Control Switch	12	60
290-00YY02-217	Non-Spring-Loaded Shutter (Jalousie) Control Switch	12	60
290-00YY02-220	Double One-way Push Button	12	60



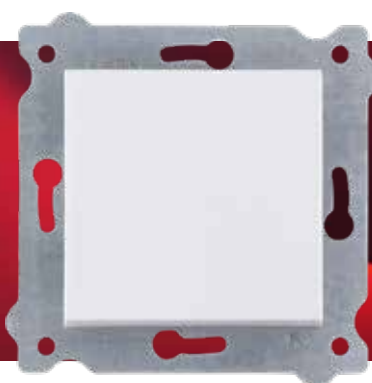

MECHANISMS

CODE	DESCRIPTION	BOX	CARTON
ILLUMINATED SWITCH			
290-00YY02-201	Illuminated One Way Switch	12	120
290-00YY02-203	Illuminated One Way Double Switch (Illuminated Commutator)	12	120
290-00YY02-206	Illuminated Light Switch	12	120
290-00YY02-210	Illuminated Two Way Switch (Illuminated Veavien)	12	60
290-00YY02-215	Illuminated One Way Switch (16A)	12	60
DIMMER			
290-00YY02-225	Dimmer 800W	10	50
290-00YY02-226	Music Broadcasting Switch	10	50
290-00YY02-227	Two Way Dimmer (Veavien Dimmer) 500W	10	50
SOCKET			
290-00YY03-235	Socket 2P	12	120
290-00YY03-237	Earthed Socket (Schuko) 2P+E	12	120
290-00YY03-238	Child Protection Earthed Socket 2P+E	12	120
290-00YY03-239	Earthed Socket with Outlet Cover (Schuko) 2P+E	12	120
290-00YY03-240	Child Protection Earthed Socket with Outlet Cover 2P+E	12	120
290-00YY03-241	UPS Socket (French Type)	12	120
290-00YY03-242	Child Protection UPS Socket (French Type)	12	120
290-00YY03-267	USB Charger Socket	12	60
290-00YY03-268	2X USB Charger Socket	12	60
290-00YY03-274	Earthed Socket (Schuko) 2P+E with Type-C	8	40
TV-SAT			
290-00YY03-257	TV Socket Through of Line with PCB	12	120
290-00YY03-258	TV Socket End of Line with PCB	12	120
290-00YY03-259	TV Socket Through of Line Filtered	12	120
290-00YY03-260	TV Socket End of Line Filtered	12	120
290-00YY03-261	SAT Socket (F Connector)	12	120
290-00YY03-262	SAT Socket (F Connector) Filtered	12	50
290-00YY03-263	TV-SAT Socket (Through of Line)	12	60
290-00YY03-264	TV-SAT Socket (End Of Line)	12	60
290-00YY03-265	Cable Outlet	12	60





MECHANISMS



CODE	DESCRIPTION	BOX	CARTON
ELECTORNIC			
290-00YY02-221	Energy Saver Optic with Illuminated + Delayed	12	60
290-00YY02-222	Energy Saver Micro Switch with Illuminated + Delayed	12	60
290-00YY02-223	Energy Saver Micro Switch with Illuminated + No Delayed	12	60
290-00YY02-224	RFID Energy Saver with illuminated + Delayed	12	60
290-00YY02-228	Energy Saver without PCB	12	60
COMMUNICATION			
290-00YY03-250	Numeric Telephone Socket (623K)	12	120
290-00YY03-251	Numeric Telephone Socket (CAT3 without Cable)	12	60
290-00YY03-252	Two-Gang Numeric Telephone Socket (2xRJ45 CAT3)	12	60
290-00YY03-253	Data Socket CAT 6	12	60
290-00YY03-254	Double Data Socket CAT 6	12	60
290-00YY03-255	Data Socket without Jack	12	60
290-00YY03-256	Data CAT6 + Numeric Telephone Socket CAT3	12	60
290-00YY03-266	USB Socket (No Charge) with JACK	12	60
290-00YY03-269	HDMI Socket with JACK	12	60
290-00YY03-270	HDMI + DATA Socket with JACK	12	60
290-00YY03-271	DATA + USB Socket (No Charge) with JACK	12	60
290-00YY03-272	HDMI + USB Socket (No Charge) with JACK	12	60
290-00YY03-273	Fiber Optic	12	60



 **ODAK**
Series





White



Silver



Smoked Gray



Titanium



Anthracite











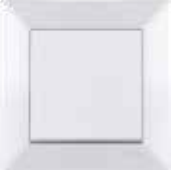

















Metallic Black



Mocha



SWITCH

 <p>One Way Switch 210-010102-200 10AX 250V ~ I EN 60669-1</p> 	 <p>One Way Double Switch 210-010102-202 10AX 250V ~ I EN 60669-1</p> 	 <p>Door Push Switch 210-010102-204 10A 250V ~ I EN 60669-1</p> 	 <p>Light Switch 210-010102-205 10A 250V ~ I EN 60669-1</p> 
 <p>Doorbell Switch 210-010102-207 10A 250V ~ I EN 60669-1</p> 	 <p>Double Light Switch 210-010102-208 10A 250V ~ I EN 60669-1</p> 	 <p>Two Way Switch (Veavien) 210-010102-209 10AX 250V ~ I EN 60669-1</p> 	 <p>Two Way Double Switch (Commutator Veavien) 210-010102-211 10AX 250V ~ I EN 60669-1</p> 
 <p>Triple Switch 210-010102-213 10AX 250V ~ I EN 60669-1</p> 	 <p>Intermediary Veavien Switch (Permutator) 210-010102-214 10AX 250V ~ I EN 60669-1</p> 	 <p>Shutter Control Switch (Jalousie) 210-010102-216 10A 250V ~ I EN 60669-1</p> 	 <p>Non-Spring-Loaded Shutter Control Switch (Jalousie) 210-010102-217 10A 250V ~ I EN 60669-1</p> 
 <p>Double One-way Push Button 210-010102-220 10A 250V ~ I EN 60669-1</p> 			

ILLUMINATED SWITCH

 <p>Illuminated One Way Switch 210-010102-201 10AX 250V ~ I EN 60669-1</p> 	 <p>Illuminated One Way Double Switch 210-010102-203 10AX 250V ~ I EN 60669-1</p> 	 <p>Illuminated Light Switch 210-010102-206 10A 250V ~ I EN 60669-1</p> 	 <p>Illuminated Two Way Switch (Illuminated Veavien) 210-010102-210 10AX 250V ~ I EN 60669-1</p> 
 <p>Illuminated One Way Switch (16A) 210-010102-215 16AX 250V ~ I EN 60669-1</p> 			

DIMMER

 <p>Dimmer 800W 210-010102-225 800W 250V ~ EN 60669-2-2</p> 	 <p>Music Broadcasting Switch 210-010102-226</p> 	 <p>Two Way Dimmer 500W 210-010102-227 500W 250V ~ EN 60669-2-2</p> 
---	---	--



SOCKET

Socket 2P

210-010103-235
16A 250V ~ I IEC 60884-1



Earthed Socket (Schuko) 2P+E

210-010103-237
16A 250V ~ I IEC 60884-1



Child Protection Earthed Socket 2P+E

210-010103-238
16A 250V ~ I IEC 60884-1



Earthed Socket with Outlet Cover (Schuko) 2P+E

210-010103-239
16A 250V ~ I IEC 60884-1



Child Protection Earthed Socket with Outlet Cover 2P+E

210-010103-240
16A 250V ~ I IEC 60884-1



UPS Socket (French Type)

210-010103-241
16A 250V ~ I IEC 60884-1



Child Protection UPS Socket (French Type)

210-010103-242
16A 250V ~ I IEC 60884-1





Earthed Socket with Type-C (20W Fast Charger)

210-010103-274
16A 250V ~ I IEC 60884-1
Output: 5V-3A/9V-2.22A/12V-1.62A/20W



Two-Gang Socket

210-010103-244
10A 250V ~ I IEC 60884-1

Two-Gang Earthed Socket

210-010103-245
16A 250V ~ I IEC 60884-1



USB Charger Socket

210-010103-267
Output: 2.1A-5V-10W



2X USB Charger Socket

210-010103-268
Output: 2.1A-5V-10W



TV - SAT

TV Socket with PCB (Through of Line)

210-010103-257



TV Socket with PCB (End of Line)

210-010103-258



TV Socket Filtered (Through of Line)

210-010103-259



TV Socket Filtered (End of Line)

210-010103-260



SAT Socket (F Connector)

210-010103-261



SAT Socket Filtered (F Connector)

210-010103-262



TV-SAT Socket (Through of Line)

210-010103-263



TV-SAT Socket (End Of Line)

210-010103-264



Cable Outlet

210-010103-265



ELECTRONIC



Energy Saver Optic with Illuminated + Delayed

210-010102-221



Energy Saver Micro Switch with Illuminated + Delayed

210-010102-222



Energy Saver Micro Switch with Illuminated + No Delayed

210-010102-223



RFID Energy Saver with illuminated + Delayed

210-010102-224



Energy Saver without PCB

210-010102-228

COMMUNICATION



Numeric Telephone Socket (623K)

210-010103-250



Numeric Telephone Socket (CAT3 without Cable)

210-010103-251



Two-Gang Numeric Telephone Socket (2xRJ45 CAT3)

210-010103-252



Data Socket CAT6

210-010103-253



Double Data Socket CAT6

210-010103-254



Data Socket without Jack

210-010103-255



Data CAT6 + Numeric Telephone Socket

210-010103-256



USB Socket with Jack (No Charge)

210-010103-266



HDMI Socket with Jack

210-010103-269



HDMI + DATA Socket with Jack

210-010103-270



DATA + USB Socket with Jack (No Charge)

210-010103-271



HDMI + USB Socket with Jack (No Charge)

210-010103-272



Fiber Optic

210-010103-273



FRAME

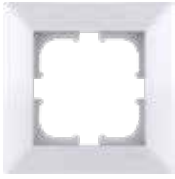

One-Gang Frame

210-010000-101



Two-Gang Frame

210-010000-102

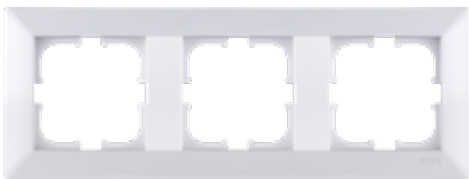

Three-Gang Frame

210-010000-103

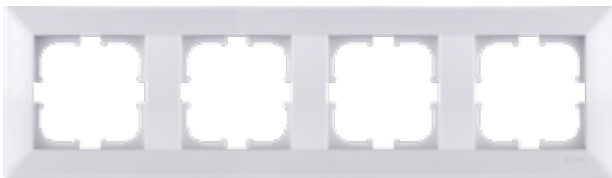

Four-Gang Frame

210-010000-104



Five-Gang Frame

210-010000-105



DAK Sales Options

1. Whole Product



2. Mechanism + Frame



ALL
IN
ONE

Please remember that all series use a common mechanism system

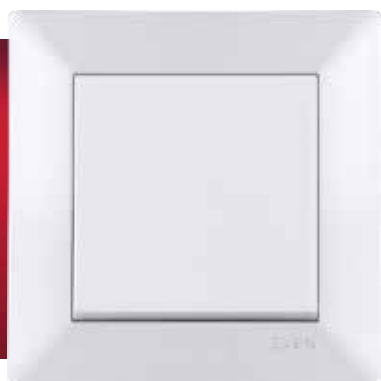

WHOLE PRODUCT

COLOR OPTIONS



01
WHITE



10
SILVER



11
SMOKED GRAY



12
TITANIUM



13
ANTHRACITE



14
METALLIC BLACK



15
MOCHA

CODE STRUCTURE

210-XXYY0A-ZZZ
WHOLE PRODUCT

XX : Frame Color

YY : Cover Color

ZZZ : Product Type



CODE	DESCRIPTION	BOX	CARTON
SWITCH			
210-XXYY02-200	One Way Switch	12	120
210-XXYY02-202	One Way Double Switch (Commutator)	12	120
210-XXYY02-204	Door Push Switch	12	120
210-XXYY02-205	Light Switch	12	120
210-XXYY02-207	Doorbell Switch	12	120
210-XXYY02-208	Double Light Switch (Commutator Light)	12	120
210-XXYY02-209	Two Way Switch (Veavien)	12	120
210-XXYY02-211	Two Way Double Pole Switch (Commutator Veavien)	12	60
210-XXYY02-213	Triple Switch	12	120
210-XXYY02-214	Intermediary Veavien (Permutator) Switch	12	60
210-XXYY02-216	Shutter (Jalousie) Control Switch	12	60
210-XXYY02-217	Non-Spring-Loaded Shutter (Jalousie) Control Switch	12	60
210-XXYY02-220	Double One-way Push Button	12	60



WHOLE PRODUCT



CODE	DESCRIPTION	BOX	CARTON
ILLUMINATED SWITCH			
210-XXYY02-201	Illuminated One Way Switch	12	120
210-XXYY02-203	Illuminated One Way Double Switch (Illuminated Commutator)	12	120
210-XXYY02-206	Illuminated Light Switch	12	120
210-XXYY02-210	Illuminated Two Way Switch (Illuminated Veavien)	12	60
210-XXYY02-215	Illuminated One Way Switch (16A)	12	60
DIMMER			
210-XXYY02-225	Dimmer 800W	10	50
210-XXYY02-226	Music Broadcasting Switch	10	50
210-XXYY02-227	Two Way Dimmer (Veavien Dimmer) 500W	10	50
SOCKET			
210-XXYY03-235	Socket 2P	12	120
210-XXYY03-237	Earthed Socket (Schuko) 2P+E	12	120
210-XXYY03-238	Child Protection Earthed Socket 2P+E	12	120
210-XXYY03-239	Earthed Socket with Outlet Cover (Schuko) 2P+E	10	100
210-XXYY03-240	Child Protection Earthed Socket with Outlet Cover 2P+E	10	100
210-XXYY03-241	UPS Socket (French Type)	12	120
210-XXYY03-242	Child Protection UPS Socket (French Type)	12	120
210-XXYY03-244	Two-Gang Socket	8	80
210-XXYY03-245	Two-Gang Earthed Socket	6	60
210-XXYY03-267	USB Charger Socket	12	60
210-XXYY03-268	2X USB Charger Socket	12	60
210-XXYY03-274	Earthed Socket (Schuko) 2P+E with Type-C	8	40
TV-SAT			
210-XXYY03-257	TV Socket Through of Line with PCB	12	120
210-XXYY03-258	TV Socket End of Line with PCB	12	120
210-XXYY03-259	TV Socket Through of Line Filtered	12	120
210-XXYY03-260	TV Socket End of Line Filtered	12	120
210-XXYY03-261	SAT Socket (F Connector)	12	120
210-XXYY03-262	SAT Socket (F Connector) Filtered	12	50
210-XXYY03-263	TV-SAT Socket (Through of Line)	12	60
210-XXYY03-264	TV-SAT Socket (End Of Line)	12	60
210-XXYY03-265	Cable Outlet	12	60



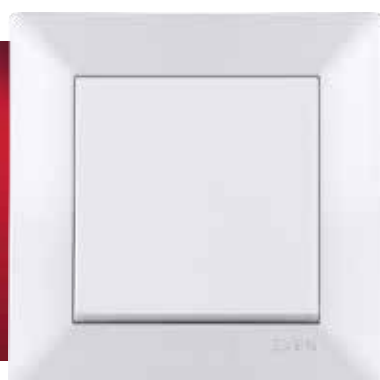

WHOLE PRODUCT



CODE	DESCRIPTION	BOX	CARTON
ELECTRONIC			
210-XXYY02-221	Energy Saver Optic with Illuminated + Delayed	12	60
210-XXYY02-222	Energy Saver Micro Switch with Illuminated + Delayed	12	60
210-XXYY02-223	Energy Saver Micro Switch with Illuminated + No Delayed	12	60
210-XXYY02-224	RFID Energy Saver with illuminated + Delayed	12	60
210-XXYY02-228	Energy Saver without PCB	12	60
COMMUNICATION			
210-XXYY03-250	Numeric Telephone Socket (623K)	12	120
210-XXYY03-251	Numeric Telephone Socket (CAT3 without Cable)	12	60
210-XXYY03-252	Two-Gang Numeric Telephone Socket (2xRJ45 CAT3)	12	60
210-XXYY03-253	Data Socket CAT 6	12	60
210-XXYY03-254	Double Data Socket CAT 6	12	60
210-XXYY03-255	Data Socket without Jack	12	60
210-XXYY03-256	Data CAT6 + Numeric Telephone Socket CAT3	12	60
210-XXYY03-266	USB Socket (No Charge) with JACK	12	60
210-XXYY03-269	HDMI Socket with JACK	12	60
210-XXYY03-270	HDMI + DATA Socket with JACK	12	60
210-XXYY03-271	DATA + USB Socket (No Charge) with JACK	12	60
210-XXYY03-272	HDMI + USB Socket (No Charge) with JACK	12	60
210-XXYY03-273	Fiber Optic	12	60
FRAME			
210-XX0000-101	One-Gang Frame	24	240
210-XX0000-102	Two-Gang Frame	24	120
210-XX0000-103	Three-Gang Frame	24	120
210-XX0000-104	Four-Gang Frame	12	60
210-XX0000-105	Five-Gang Frame	12	60



MECHANISMS



COLOR OPTIONS



01
WHITE

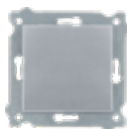

10
SILVER

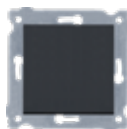

11
SMOKED GRAY

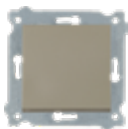

12
TITANIUM

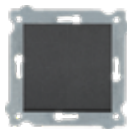

13
ANTHRACITE



14
METALLIC BLACK

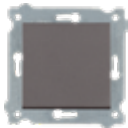

15
MOCHA

CODE STRUCTURE

290-00YY0A-ZZZ
MECHANISMS

YY : Cover Color

ZZZ : Product Type

CODE	DESCRIPTION	BOX	CARTON
SWITCH			
290-00YY02-200	One Way Switch	12	120
290-00YY02-202	One Way Double Switch (Commutator)	12	120
290-00YY02-204	Door Push Switch	12	120
290-00YY02-205	Light Switch	12	120
290-00YY02-207	Doorbell Switch	12	120
290-00YY02-208	Double Light Switch (Commutator Light)	12	120
290-00YY02-209	Two Way Switch (Veavien)	12	120
290-00YY02-211	Two Way Double Pole Switch (Commutator Veavien)	12	60
290-00YY02-213	Triple Switch	12	120
290-00YY02-214	Intermediary Veavien (Permutator) Switch	12	60
290-00YY02-216	Shutter (Jalousie) Control Switch	12	60
290-00YY02-217	Non-Spring-Loaded Shutter (Jalousie) Control Switch	12	60
290-00YY02-220	Double One-way Push Button	12	60



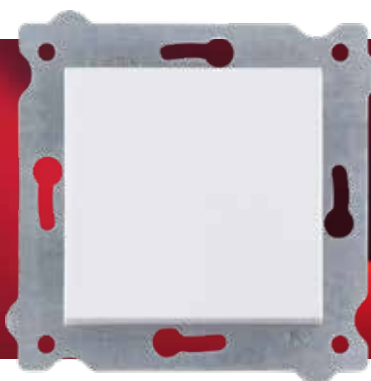

MECHANISMS



CODE	DESCRIPTION	BOX	CARTON
ILLUMINATED SWITCH			
290-00YY02-201	Illuminated One Way Switch	12	120
290-00YY02-203	Illuminated One Way Double Switch (Illuminated Commutator)	12	120
290-00YY02-206	Illuminated Light Switch	12	120
290-00YY02-210	Illuminated Two Way Switch (Illuminated Veavien)	12	60
290-00YY02-215	Illuminated One Way Switch (16A)	12	60
DIMMER			
290-00YY02-225	Dimmer 800W	10	50
290-00YY02-226	Music Broadcasting Switch	10	50
290-00YY02-227	Two Way Dimmer (Veavien Dimmer) 500W	10	50
SOCKET			
290-00YY03-235	Socket 2P	12	120
290-00YY03-237	Earthed Socket (Schuko) 2P+E	12	120
290-00YY03-238	Child Protection Earthed Socket 2P+E	12	120
290-00YY03-239	Earthed Socket with Outlet Cover (Schuko) 2P+E	12	120
290-00YY03-240	Child Protection Earthed Socket with Outlet Cover 2P+E	12	120
290-00YY03-241	UPS Socket (French Type)	12	120
290-00YY03-242	Child Protection UPS Socket (French Type)	12	120
290-00YY03-267	USB Charger Socket	12	60
290-00YY03-268	2X USB Charger Socket	12	60
290-00YY03-274	Earthed Socket (Schuko) 2P+E with Type-C	8	40
TV-SAT			
290-00YY03-257	TV Socket Through of Line with PCB	12	120
290-00YY03-258	TV Socket End of Line with PCB	12	120
290-00YY03-259	TV Socket Through of Line Filtered	12	120
290-00YY03-260	TV Socket End of Line Filtered	12	120
290-00YY03-261	SAT Socket (F Connector)	12	120
290-00YY03-262	SAT Socket (F Connector) Filtered	12	50
290-00YY03-263	TV-SAT Socket (Through of Line)	12	60
290-00YY03-264	TV-SAT Socket (End Of Line)	12	60
290-00YY03-265	Cable Outlet	12	60



MECHANISMS



CODE	DESCRIPTION	BOX	CARTON
ELECTRONIC			
290-00YY02-221	Energy Saver Optic with Illuminated + Delayed	12	60
290-00YY02-222	Energy Saver Micro Switch with Illuminated + Delayed	12	60
290-00YY02-223	Energy Saver Micro Switch with Illuminated + No Delayed	12	60
290-00YY02-224	RFID Energy Saver with illuminated + Delayed	12	60
290-00YY02-228	Energy Saver without PCB	12	60
COMMUNICATION			
290-00YY03-250	Numeric Telephone Socket (623K)	12	120
290-00YY03-251	Numeric Telephone Socket (CAT3 without Cable)	12	60
290-00YY03-252	Two-Gang Numeric Telephone Socket (2xRJ45 CAT3)	12	60
290-00YY03-253	Data Socket CAT 6	12	60
290-00YY03-254	Double Data Socket CAT 6	12	60
290-00YY03-255	Data Socket without Jack	12	60
290-00YY03-256	Data CAT6 + Numeric Telephone Socket CAT3	12	60
290-00YY03-266	USB Socket (No Charge) with JACK	12	60
290-00YY03-269	HDMI Socket with JACK	12	60
290-00YY03-270	HDMI + DATA Socket with JACK	12	60
290-00YY03-271	DATA + USB Socket (No Charge) with JACK	12	60
290-00YY03-272	HDMI + USB Socket (No Charge) with JACK	12	60
290-00YY03-273	Fiber Optic	12	60



COMFORT
Series





Iron



Magnetic Gray



Space Black

SWITCH



One Way Switch
220-091402-200
10AX 250V ~ I EN 60669-1



One Way Double Switch
220-091402-202
10AX 250V ~ I EN 60669-1



Door Push Switch
220-091402-204
10A 250V ~ I EN 60669-1



Light Switch
220-091402-205
10A 250V ~ I EN 60669-1



Doorbell Switch
220-091402-207
10A 250V ~ I EN 60669-1



Double Light Switch
220-091402-208
10A 250V ~ I EN 60669-1



Two Way Switch (Veavien)
220-091402-209
10AX 250V ~ I EN 60669-1



Two Way Double Switch (Commutator Veavien)
220-091402-211
10AX 250V ~ I EN 60669-1



Triple Switch
220-091402-213
10AX 250V ~ I EN 60669-1



Intermediary Veavien Switch (Permutator)
220-091402-214
10AX 250V ~ I EN 60669-1



Shutter Control Switch (Jalousie)
220-091402-216
10A 250V ~ I EN 60669-1



Non-Spring-Loaded Shutter Control Switch (Jalousie)
220-091402-217
10A 250V ~ I EN 60669-1



Double One-way Push Button
220-091402-220
10A 250V ~ I EN 60669-1

ILLUMINATED SWITCH



Illuminated One Way Switch
220-091402-201
10AX 250V ~ I EN 60669-1



Illuminated Light Switch
220-091402-206
10A 250V ~ I EN 60669-1



Illuminated Two Way Switch (Illuminated Veavien)
220-091402-210
10AX 250V ~ I EN 60669-1



Illuminated One Way Double Switch
220-091402-203
10AX 250V ~ I EN 60669-1



Illuminated One Way Switch (16A)
220-091402-215
16AX 250V ~ I EN 60669-1

DIMMER



Dimmer 800W
220-091402-225
800W 250V ~ EN 60669-2-2



Music Broadcasting Switch
220-091402-226



Two Way Dimmer 500W
220-091402-227
500W 250V ~ EN 60669-2-2



SOCKET



Socket 2P
220-091403-235
16A 250V ~ I IEC 60884-1



Earthed Socket (Schuko)
2P+E
220-091403-237
16A 250V ~ I IEC 60884-1



Child Protection Earthed
Socket 2P+E
220-091403-238
16A 250V ~ I IEC 60884-1



Earthed Socket with Out-
let Cover (Schuko) 2P+E
220-091403-239
16A 250V ~ I IEC 60884-1



Child Protection Earthed
Socket with Outlet Cover
2P+E
220-091403-240
16A 250V ~ I IEC 60884-1



UPS Socket
(French Type)
210-010103-241
16A 250V ~ I IEC 60884-1



Child Protection UPS
Socket (French Type)
220-091403-242
16A 250V ~ I IEC 60884-1



Earthed Socket with Type-C
(20W Fast Charger)
220-091403-274
16A 250V ~ I IEC 60884-1
Output: 5V-3A/9V-2.22A/12V-1.62A/20W



Two-Gang Socket
220-091403-244
10A 250V ~ I IEC 60884-1



Two-Gang Earthed
Socket
220-091403-245
16A 250V ~ I IEC 60884-1



USB Charger Socket
220-091403-267
Output: 2.1A-5V-10W



2X USB Charger Socket
220-091403-268
Output: 2.1A-5V-10W

TV - SAT



TV Socket with PCB
(Through of Line)
220-091403-257



TV Socket with PCB
(End of Line)
220-091403-258



TV Socket Filtered
(Through of Line)
220-091403-259



TV Socket Filtered
(End of Line)
220-091403-260



SAT Socket
(F Connector)
220-091403-261



SAT Socket Filtered
(F Connector)
220-091403-262



TV-SAT Socket
(Through of Line)
220-091403-263



TV-SAT Socket
(End Of Line)
220-091403-264



Cable Outlet
220-091403-265

ELECTRONIC



Energy Saver Optic with Illuminated + Delayed

220-091402-221



Energy Saver Micro Switch with Illuminated + Delayed

220-091402-222



Energy Saver Micro Switch with Illuminated + No Delayed

220-091402-223



RFID Energy Saver with illuminated + Delayed

220-091402-224



Energy Saver without PCB

220-091402-228

COMMUNICATION



Numeric Telephone Socket (623K)

220-091403-250



Numeric Telephone Socket (CAT3 without Cable)

220-091403-251



Two-Gang Numeric Telephone Socket (2xRJ45 CAT3)

220-091403-252



Data Socket CAT6

220-091403-253



Double Data Socket CAT6

220-091403-254

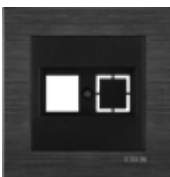

Data Socket without Jack

220-091403-255



Data CAT6 + Numeric Telephone Socket CAT3

220-091403-256



USB Socket with Jack (No Charge)

220-091403-266



HDMI Socket with Jack

220-091403-269



HDMI + DATA Socket with Jack

220-091403-270



DATA + USB Socket with Jack (No Charge)

220-091403-271



HDMI + USB Socket with Jack (No Charge)

220-091403-272



Fiber Optic

220-091403-273



FRAME



One-Gang Frame

220-090000-101



Two-Gang Frame

220-090000-102



Three-Gang Frame

220-090000-103



Four-Gang Frame

220-090000-104



Five-Gang Frame

220-090000-105



Two-Gang Socket Frame

220-090000-110



COMFORT Sales Options

1. Mechanism + Frame



ALL
IN
ONE

Please remember that all series use a common mechanism system

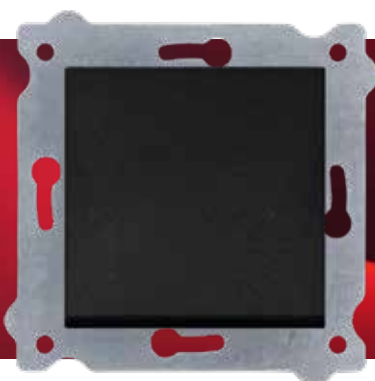

MECHANISMS

COLOR OPTIONS



01
WHITE

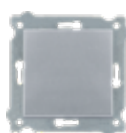

10
SILVER

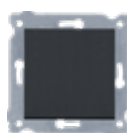

11
SMOKED GRAY

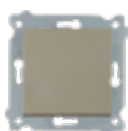

12
TITANIUM

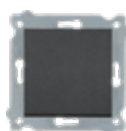

13
ANTHRACITE



14
METALLIC BLACK

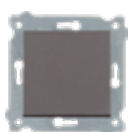

15
MOCHA



05
IRON



07
MAGNETIC GRAY



09
SPACE BLACK

CODE STRUCTURE

290-00YY0A-ZZZ
MECHANISMS

YY : Cover Color

ZZZ : Product Type

COMFORT colors for frames only

CODE	DESCRIPTION	BOX	CARTON
SWITCH			
290-00YY02-200	One Way Switch	12	120
290-00YY02-202	One Way Double Switch (Commutator)	12	120
290-00YY02-204	Door Push Switch	12	120
290-00YY02-205	Light Switch	12	120
290-00YY02-207	Doorbell Switch	12	120
290-00YY02-208	Double Light Switch (Commutator Light)	12	120
290-00YY02-209	Two Way Switch (Veavien)	12	120
290-00YY02-211	Two Way Double Pole Switch (Commutator Veavien)	12	60
290-00YY02-213	Triple Switch	12	120
290-00YY02-214	Intermediary Veavien (Permutator) Switch	12	60
290-00YY02-216	Shutter (Jalousie) Control Switch	12	60
290-00YY02-217	Non-Spring-Loaded Shutter (Jalousie) Control Switch	12	60
290-00YY02-220	Double One-way Push Button	12	60

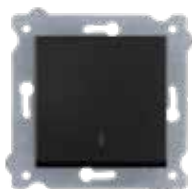



MECHANISMS

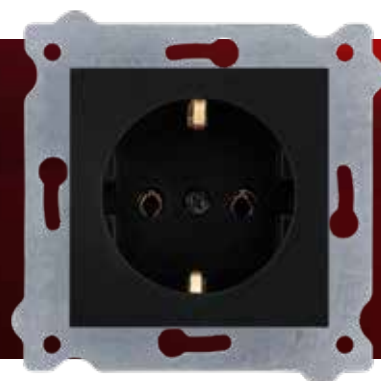

CODE	DESCRIPTION	BOX	CARTON
ILLUMINATED SWITCH			
290-00YY02-201	Illuminated One Way Switch	12	120
290-00YY02-203	Illuminated One Way Double Switch (Illuminated Commutator)	12	120
290-00YY02-206	Illuminated Light Switch	12	120
290-00YY02-210	Illuminated Two Way Switch (Illuminated Veavien)	12	60
290-00YY02-215	Illuminated One Way Switch (16A)	12	60
DIMMER			
290-00YY02-225	Dimmer 800W	10	50
290-00YY02-226	Music Broadcasting Switch	10	50
290-00YY02-227	Two Way Dimmer (Veavien Dimmer) 500W	10	50
SOCKET			
290-00YY03-235	Socket 2P	12	120
290-00YY03-237	Earthed Socket (Schuko) 2P+E	12	120
290-00YY03-238	Child Protection Earthed Socket 2P+E	12	120
290-00YY03-239	Earthed Socket with Outlet Cover (Schuko) 2P+E	12	120
290-00YY03-240	Child Protection Earthed Socket with Outlet Cover 2P+E	12	120
290-00YY03-241	UPS Socket (French Type)	12	120
290-00YY03-242	Child Protection UPS Socket (French Type)	12	120
290-00YY03-267	USB Charger Socket	12	60
290-00YY03-268	2X USB Charger Socket	12	60
290-00YY03-274	Earthed Socket (Schuko) 2P+E with Type-C	8	40
TV-SAT			
290-00YY03-257	TV Socket Through of Line with PCB	12	120
290-00YY03-258	TV Socket End of Line with PCB	12	120
290-00YY03-259	TV Socket Through of Line Filtered	12	120
290-00YY03-260	TV Socket End of Line Filtered	12	120
290-00YY03-261	SAT Socket (F Connector)	12	120
290-00YY03-262	SAT Socket (F Connector) Filtered	12	50
290-00YY03-263	TV-SAT Socket (Through of Line)	12	60
290-00YY03-264	TV-SAT Socket (End Of Line)	12	60
290-00YY03-265	Cable Outlet	12	60



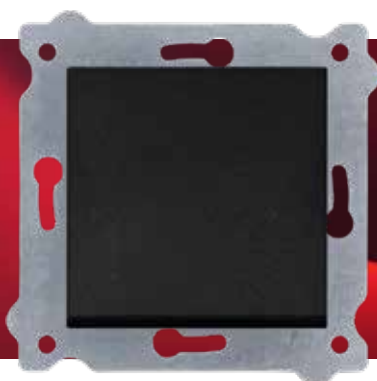

MECHANISMS

CODE	DESCRIPTION	BOX	CARTON
ELECTRONIC			
290-00YY02-221	Energy Saver Optic with Illuminated + Delayed	12	60
290-00YY02-222	Energy Saver Micro Switch with Illuminated + Delayed	12	60
290-00YY02-223	Energy Saver Micro Switch with Illuminated + No Delayed	12	60
290-00YY02-224	RFID Energy Saver with illuminated + Delayed	12	60
290-00YY02-228	Energy Saver without PCB	12	60
COMMUNICATION			
290-00YY03-250	Numeric Telephone Socket (623K)	12	120
290-00YY03-251	Numeric Telephone Socket (CAT3 without Cable)	12	60
290-00YY03-252	Two-Gang Numeric Telephone Socket (2xRJ45 CAT3)	12	60
290-00YY03-253	Data Socket CAT 6	12	60
290-00YY03-254	Double Data Socket CAT 6	12	60
290-00YY03-255	Data Socket without Jack	12	60
290-00YY03-256	Data CAT6 + Numeric Telephone Socket CAT3	12	60
290-00YY03-266	USB Socket (No Charge) with JACK	12	60
290-00YY03-269	HDMI Socket with JACK	12	60
290-00YY03-270	HDMI + DATA Socket with JACK	12	60
290-00YY03-271	DATA + USB Socket (No Charge) with JACK	12	60
290-00YY03-272	HDMI + USB Socket (No Charge) with JACK	12	60
290-00YY03-273	Fiber Optic	12	60
FRAME			
220-XX0000-101	One-Gang Frame	24	240
220-XX0000-102	Two-Gang Frame	24	120
220-XX0000-103	Three-Gang Frame	24	120
220-XX0000-104	Four-Gang Frame	12	60
220-XX0000-105	Five-Gang Frame	12	60

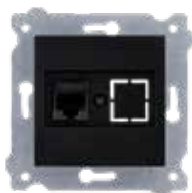

You may replace **XX** codes by frame color codes
 You may replace **YY** codes by cover/button color codes
 The frames are suitable for both vertical and horizontal use.



245

Two-Gang Earthed Socket

244

Two-Gang Socket

While the frames of KARELL and ODAK series are produced together with the cover part, but cover part is produced separately for COMFORT series



COMFORT series is produced from durable raw material with special self-colored metal content



Magnetic Gray



Space Black



Iron



You can visit our website to discover more options and create your dream color combinations with the product wizard





TECHNICAL SPECIFICATIONS



KARELL

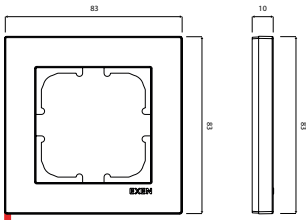

KARELL One-Gang Frame

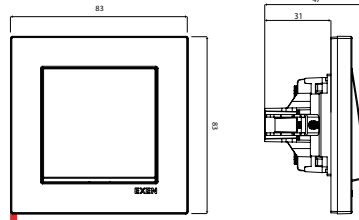

KARELL One Way Switch

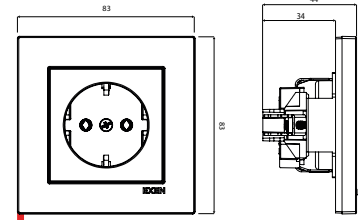

KARELL Earthed Socket (Schuko)

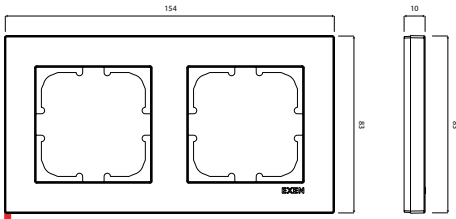

KARELL Two-Gang Frame

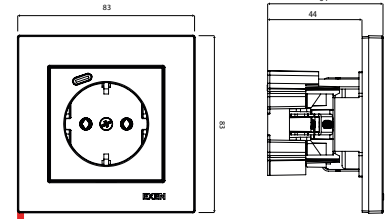

KARELL Earthed Socket (Schuko) with Type-C

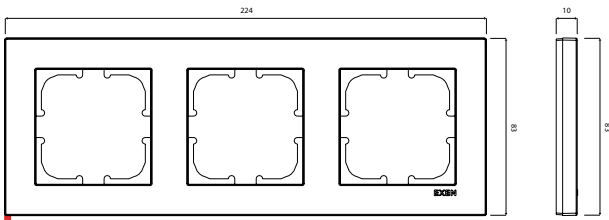

KARELL Three-Gang Frame

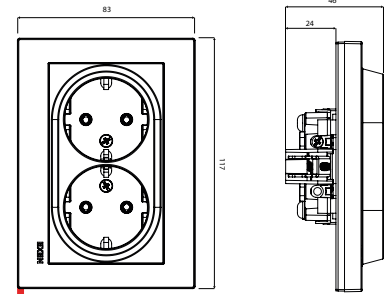

KARELL Two-Gang Earthed Socket

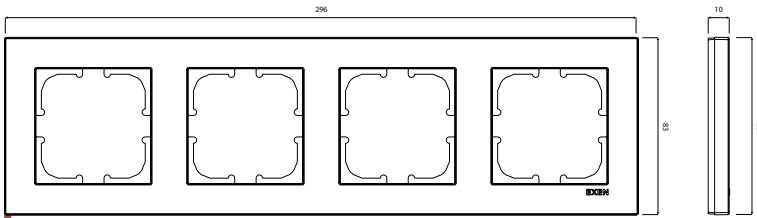

KARELL Four-Gang Frame

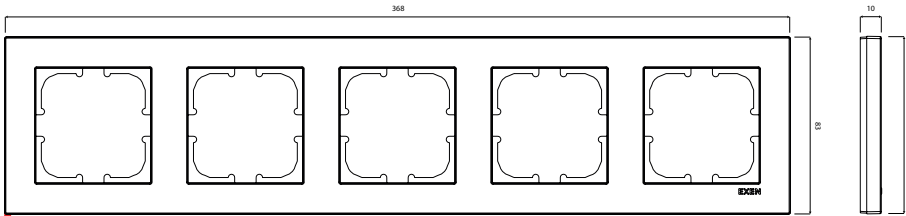

KARELL Five-Gang Frame

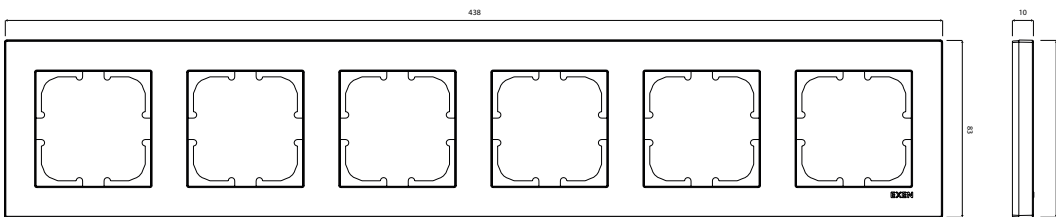

KARELL Six-Gang Frame

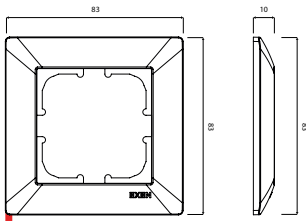

ODAK One-Gang Frame

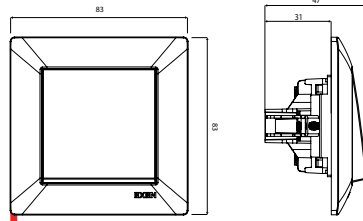

ODAK One Way Switch

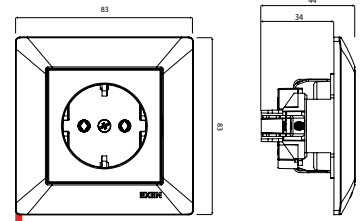

ODAK Earthed Socket (Schuko)

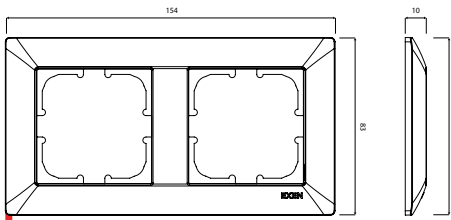

ODAK Two-Gang Frame

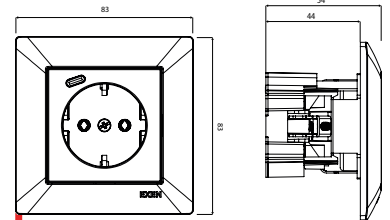

ODAK Earthed Socket (Schuko) with Type-C

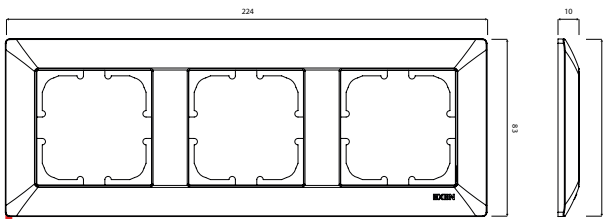

ODAK Three-Gang Frame

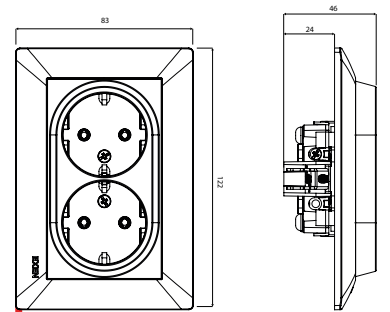

ODAK Two-Gang Earthed Socket

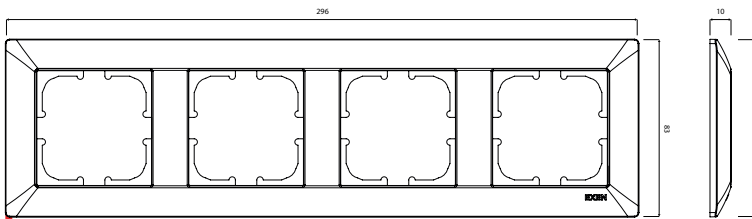

ODAK Four-Gang Frame

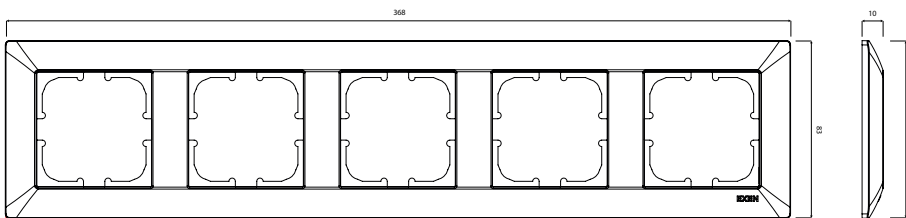

ODAK Five-Gang Frame



COMFORT

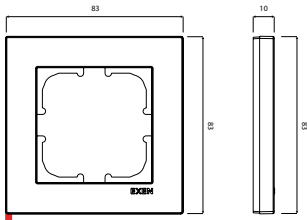

COMFORT One-Gang Frame

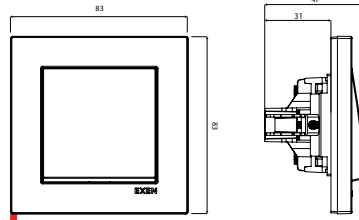

COMFORT One Way Switch

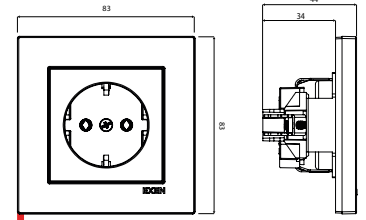

COMFORT Earthed Socket (Schuko)

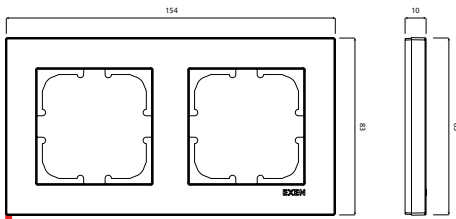

COMFORT Two-Gang Frame

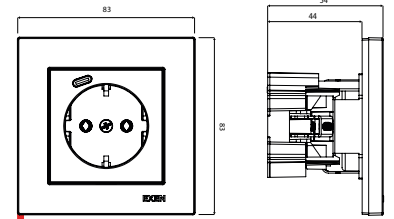

COMFORT Earthed Socket (Schuko) with Type-C

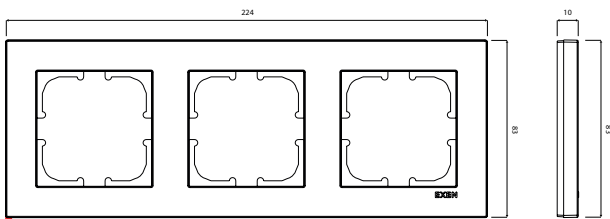

COMFORT Three-Gang Frame

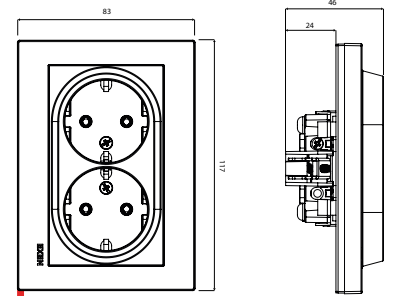

COMFORT Two-Gang Earthed Socket

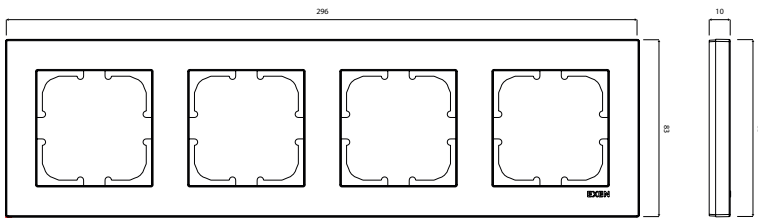

COMFORT Four-Gang Frame

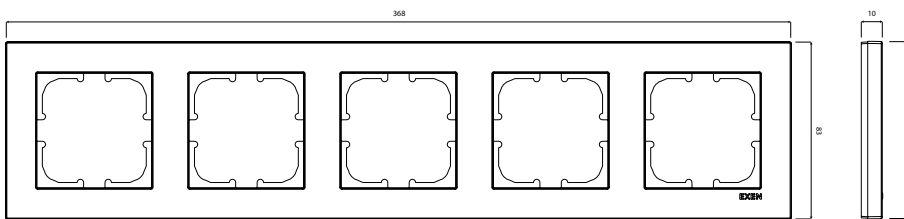

COMFORT Five-Gang Frame

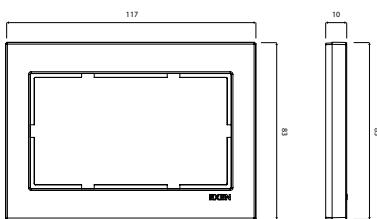

COMFORT Two-Gang Socket Frame

EXEN SWITCH MECHANISM
TECHNICAL SPECIFICATIONS

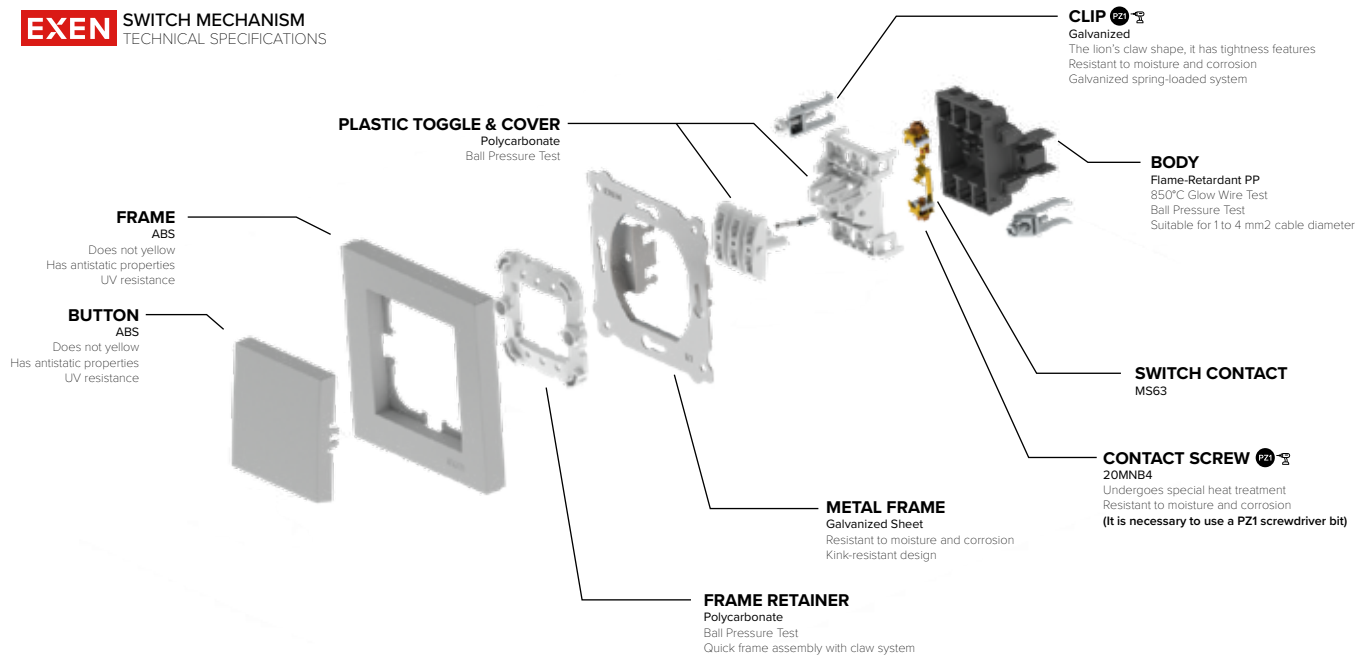

EXEN SOCKET MECHANISM
TECHNICAL SPECIFICATIONS

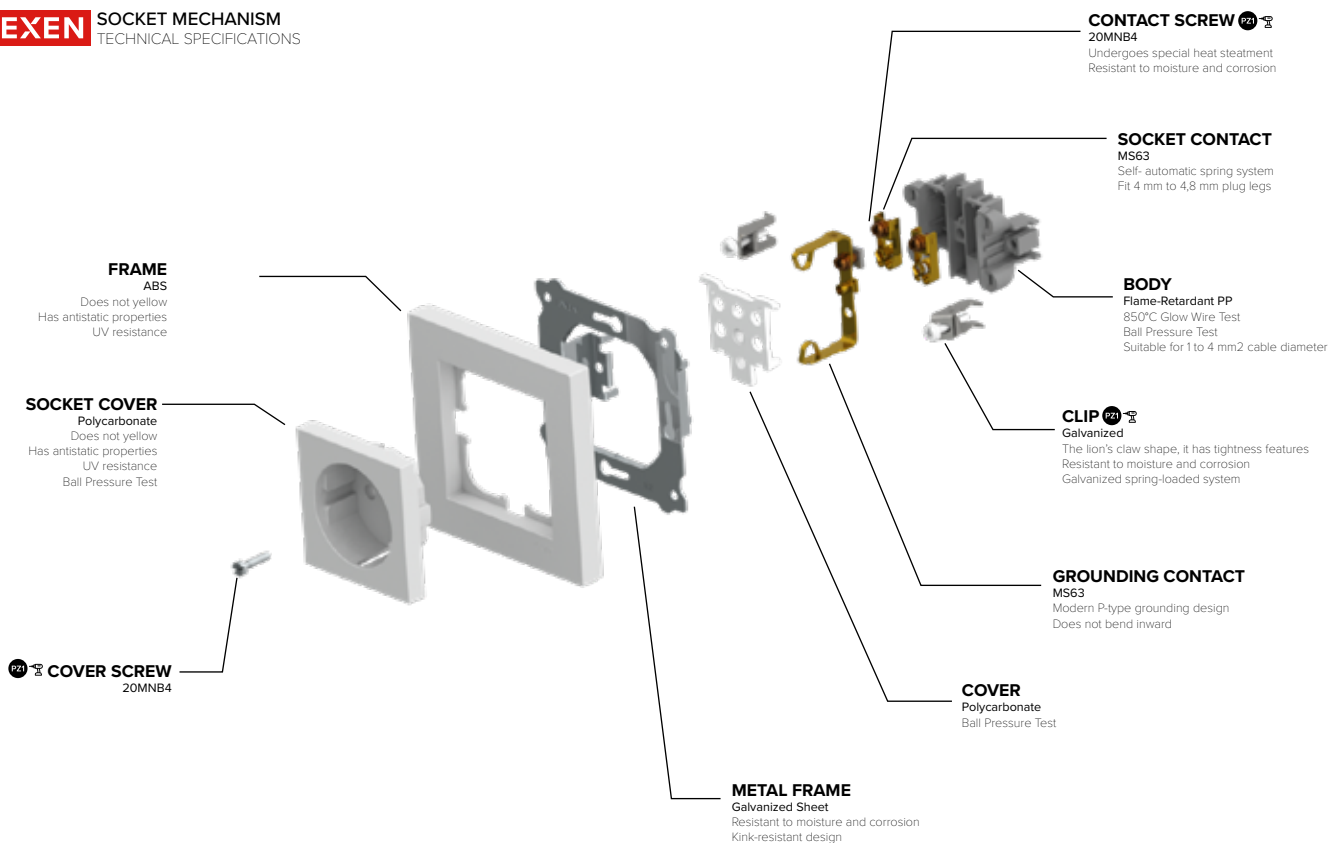

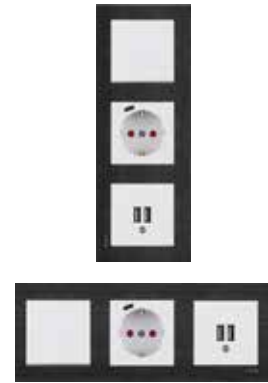
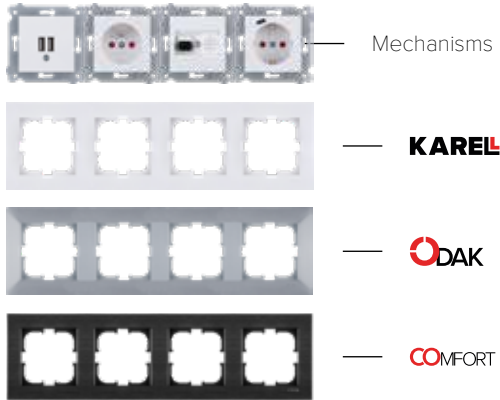

ALL IN ONE EXEN uses a single mechanism system, you can use all color and model combinations in a common way

90° Symmetrical design makes the frame suitable for both horizontal and vertical use





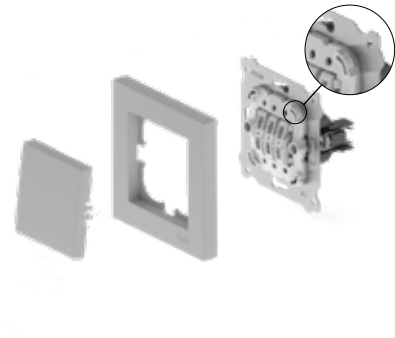



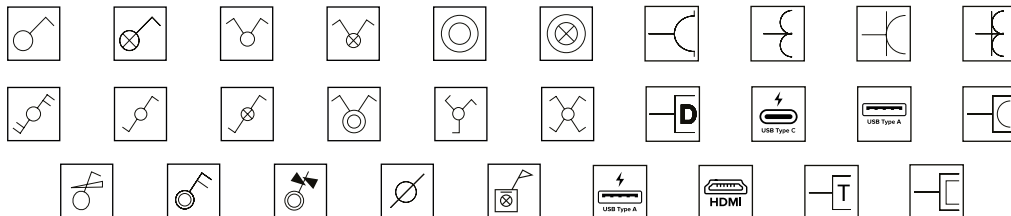

ABS High quality UV resistant and antistatic raw material with the advantage of long lasting use

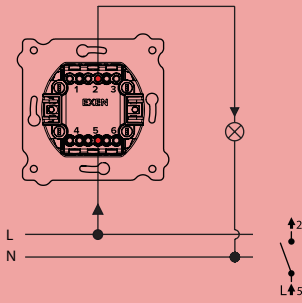
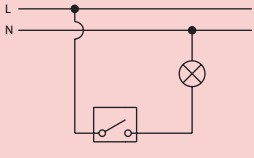

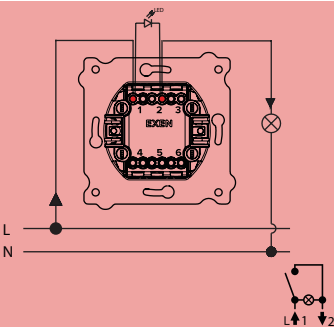
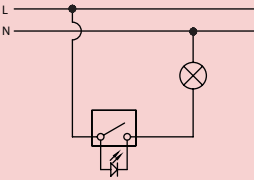
Quick Assem Fast frame assembly thanks to clip-on construction

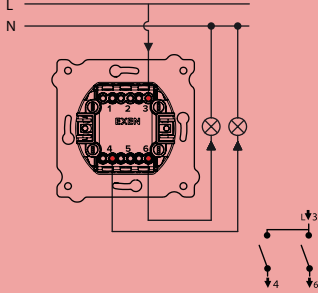
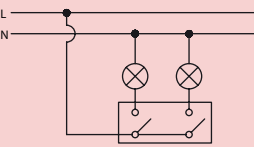

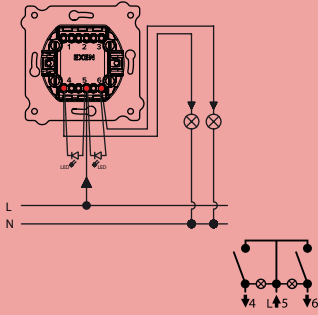
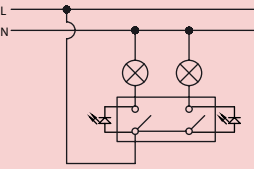

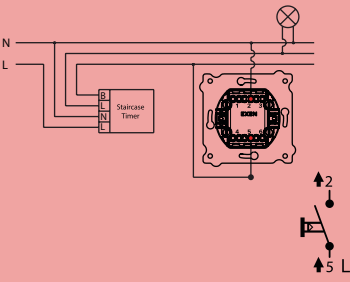
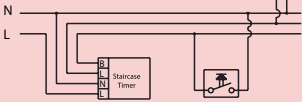



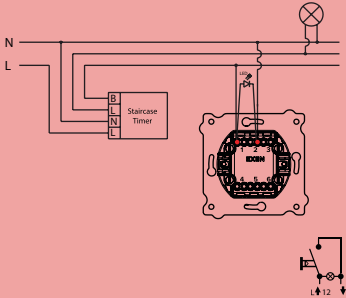
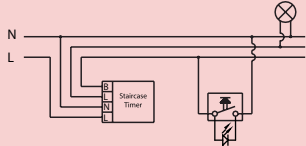

Lightbulb icon Mechanism systems that are constantly expanding and will produce solutions for different scenarios

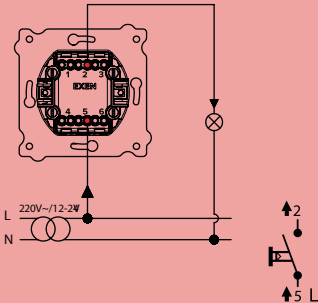
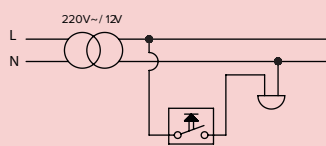

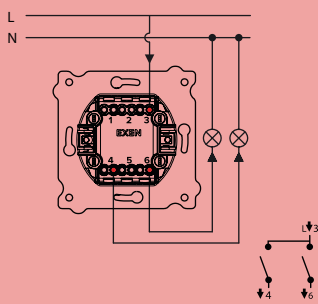
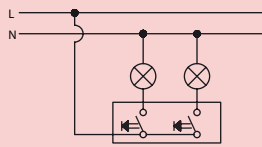

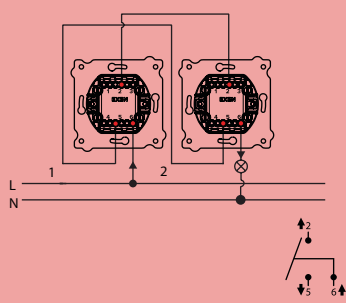
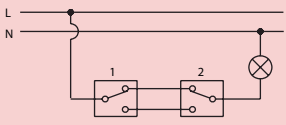

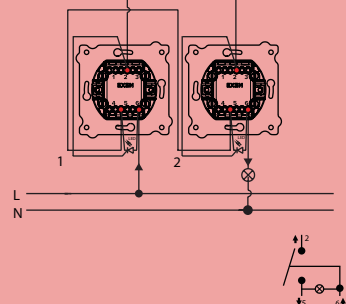
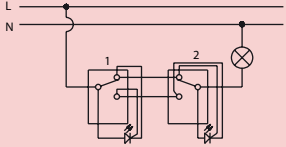

SWITCHES			
Product	Technical Specifications	Wiring Diagram	Circuit Diagram
<p>200</p> <p>One Way Switch</p> 	<ul style="list-style-type: none"> A switch that allows you to turn a single light or a group of lights on or off from one point. Screwed installation. One way. 10AX 250V ~ EN 60669-1 		
<p>201</p> <p>Illuminated One Way Switch</p> 	<ul style="list-style-type: none"> A switch that allows you to turn a single light or a group of lights on or off from one point. Screwed installation. One way. Within blue LED indicator. 10AX 250V ~ EN 60669-1 		
<p>202</p> <p>One Way Double Switch (Commutator)</p> 	<ul style="list-style-type: none"> A switch that allows you to turn a two different lights or a group of lights on or off from one point. Screwed installation. Two buttons - One way. Single entry point 10AX 250V ~ EN 60669-1 		
<p>203</p> <p>Illuminated One Way Double Switch (Illuminated Commutator)</p> 	<ul style="list-style-type: none"> A switch that allows you to turn a two different lights or a group of lights on or off from one point. Screwed installation. Two buttons - One way. Single entry point Within blue LEDs indicators. 10AX 250V ~ EN 60669-1 		
<p>204 - 205</p> <p>Door Push Switch Light Switch</p> 	<ul style="list-style-type: none"> Sends control signals to activate external triggering circuits, such as staircase timers, motion sensors, lights or automation systems. Screwed installation. One way. Instant triggering with a spring-loaded mechanism. 10A 250V ~ EN 60669-1 		

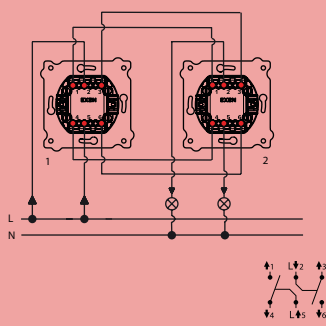
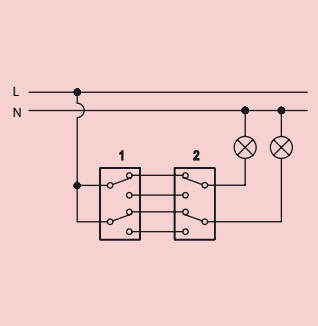

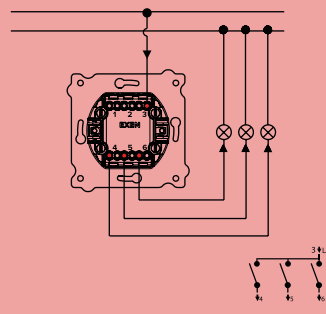
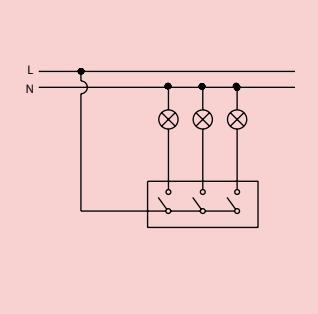
SWITCHES

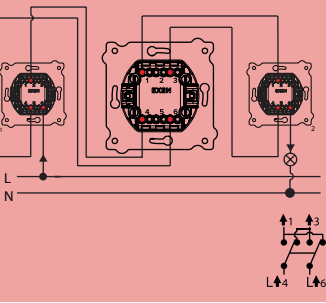
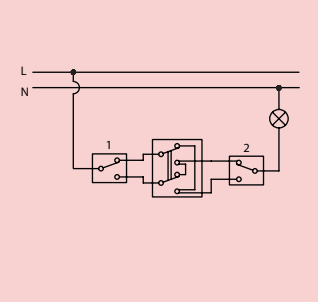

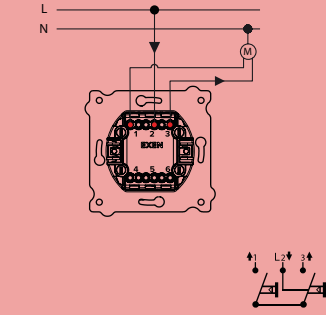
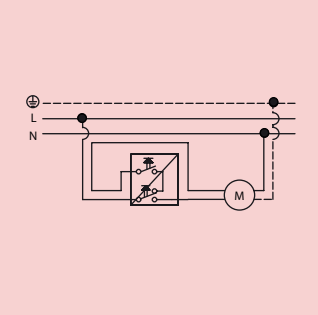

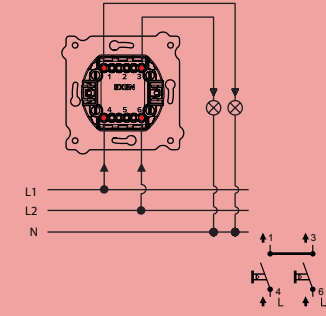
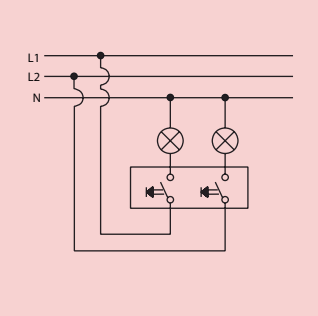



Product	Technical Specifications	Wiring Diagram	Circuit Diagram
<p>206</p> <p>Illuminated Light Switch</p> 	<ul style="list-style-type: none"> Sends control signals to activate external triggering circuits, such as staircase timers, motion sensors, lights or automation systems. Screwed installation. One way. Instant triggering with a spring-loaded mechanism. Within blue LED indicator. 10A 250V ~ EN 60669-1 		
<p>207</p> <p>Doorbell Switch</p> 	<ul style="list-style-type: none"> Controls doorbell. Screwed installation. One way. Instant triggering with a spring-loaded mechanism. 10A 250V ~ EN 60669-1 		
<p>208</p> <p>Double Light Switch (Commutator Light)</p> 	<ul style="list-style-type: none"> Sends 2 different control signals to activate lights. Screwed installation. One way. Instant triggering with a spring-loaded mechanism. 10A 250V ~ EN 60669-1 		
<p>209</p> <p>Two Way Switch (Veavien)</p> 	<ul style="list-style-type: none"> A switch that allows you to turn a single light or a group of lights on or off from two different points. Screwed installation. Two way 10AX 250V ~ EN 60669-1 		
<p>210</p> <p>Illuminated Two Way Switch (Illuminated Veavien)</p> 	<ul style="list-style-type: none"> A switch that allows you to turn a single light or a group of lights on or off from two different points. Screwed installation. Two way Within blue LED indicator. 10AX 250V ~ EN 60669-1 		

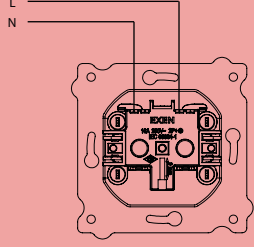
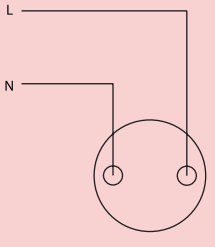

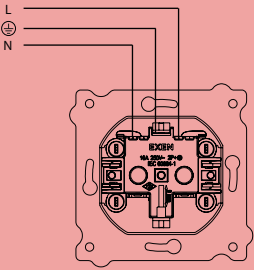
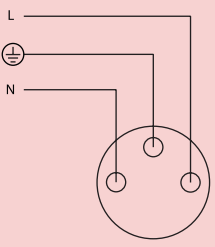

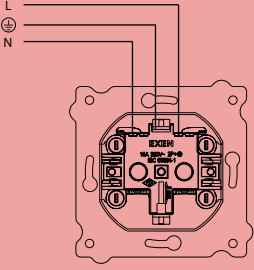
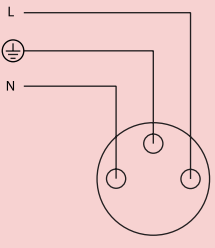

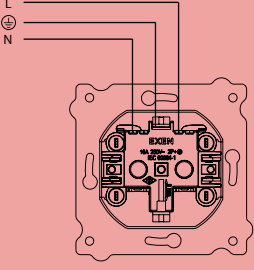
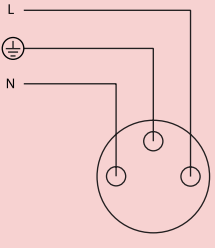

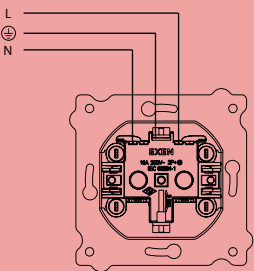
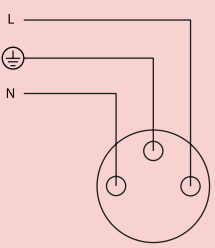
SWITCHES

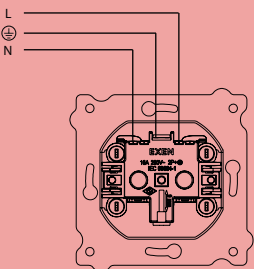
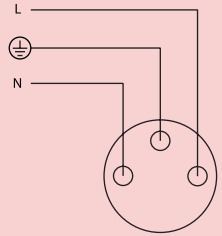
Product	Technical Specifications	Wiring Diagram	Circuit Diagram
<p>211</p> <p>Two Way Double Switch (Commutator Veavien)</p> 	<ul style="list-style-type: none"> A switch that allows you to turn two light or a group of lights on or off from two different points with two buttons. Screwed installation. Two way, two inlet. 10AX 250V ~ EN 60669-1 		
<p>213</p> <p>Triple Switch</p> 	<ul style="list-style-type: none"> A switch that allows you to turn three light or a group of lights on or off from one point. Screwed installation. One way 10AX 250V ~ EN 60669-1 		
<p>214</p> <p>Intermediary Veavien Switch (Permutator)</p> 	<ul style="list-style-type: none"> A switch that allows you to turn a light or a group of lights on or off from more than two different points. Screwed installation. Two way. 10AX 250V ~ EN 60669-1 		
<p>216</p> <p>Shutter Control Switch (Jalousie)</p> 	<ul style="list-style-type: none"> A switch that manages the up and down movement of blind motors by reversing their rotation direction using two buttons. Two way, two inlet. Screwed installation. Prevents simultaneous electrical activation of two motors. Contact structure is designed to prevent two directions from operating simultaneously. 10A 250V ~ EN 60669-1 		
<p>220</p> <p>Double One Way Push Button</p> 	<ul style="list-style-type: none"> Sends 2 different control signals to activate external triggering circuits, such as staircase timers, motion sensors, lights or automation systems. Screwed installation. One way. Instant triggering with a spring-loaded mechanism. 10A 250V ~ EN 60669-1 		

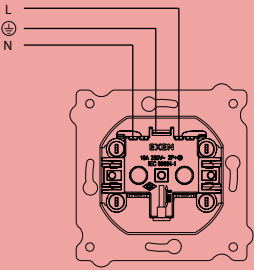
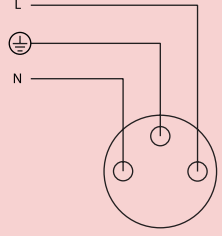

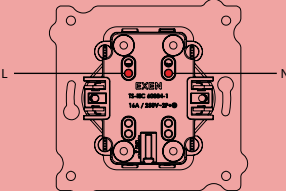
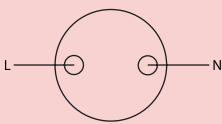
SOCKETS

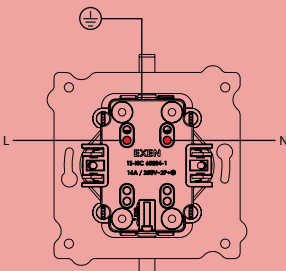
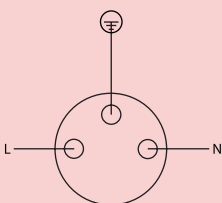
Product	Technical Specifications	Wiring Diagram	Circuit Diagram
235 Socket 2P 	<ul style="list-style-type: none"> • 2P • Screwed installation • 16A 250V ~ 		
237 Earthed Socket (Schuko) 	<ul style="list-style-type: none"> • 2P+E • Screwed installation • 16A 250V ~ IEC 60884-1 		
238 Child Protection Earthed Socket 	<ul style="list-style-type: none"> • 2P+E • Screwed installation • Child protection • 16A 250V ~ IEC 60884-1 		
239 Earthed Socket with Outlet Cover 	<ul style="list-style-type: none"> • 2P+E • Screwed installation • Springless 3-stage, 180 degree openable cover • 16A 250V ~ IEC 60884-1 		
240 Child Protection Earthed Socket with Outlet Cover 	<ul style="list-style-type: none"> • 2P+E • Screwed installation • Springless 3-stage, 180 degree openable cover • Child protection • 16A 250V ~ IEC 60884-1 		

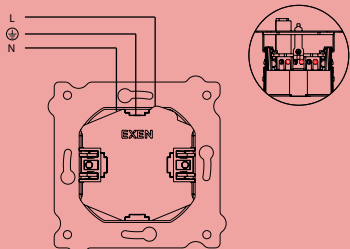
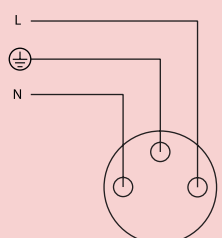
SOCKETS			
Product	Technical Specifications	Wiring Diagram	Circuit Diagram
<p>241</p> <p>UPS Socket (French Type)</p> 	<ul style="list-style-type: none"> • 2P+E • Screwed installation • French standart • Red cover option for UPS • 16A 250V ~ IEC 60884-1 		
<p>242</p> <p>Child Protection UPS Socket (French Type)</p> 	<ul style="list-style-type: none"> • 2P+E • Screwed installation • French standart • Child protection • Red cover option for UPS • 16A 250V ~ IEC 60884-1 		
<p>244</p> <p>Two-Gang Socket</p> 	<ul style="list-style-type: none"> • 2P • Screwed installation • 16A 250V ~ 		
<p>245</p> <p>Two-Gang Earthed Socket</p> 	<ul style="list-style-type: none"> • 2P+E • Screwed installation • 16A 250V ~ IEC 60884-1 		
<p>274</p> <p>Earthed Socket (Schuko) 2P+E with Type-C Charger</p> 	<ul style="list-style-type: none"> • 2P+E • Screwed installation • 20W PD fast charging • Child protection • Output: 5V - 3A / 9V - 2.22A / 12V - 1.67A • Mechanism compatible with multiple frameworks • 16A 250V ~ IEC 60884-1 		







EXEN

EXEN ELEKTRİK SANAYİ VE TİCARET A.Ş.

Fatih Mah. Yahya Kemal Cad. Savcı Sok. No:1/1 Arnavutköy / İstanbul
T: +90 212 954 09 09 F: +90 212 597 82 06 info@exenelektrik.com

 exenelektrik  exenelektrik  exenelektrik  exenelektrik

ALL EYES ARE ON